

# NOWOŚCI NEWS 2018

## SYSTEM SGA: SCHODKI Z NIEOGRANICZALNYMI MOŻLIWYMI KOMPOZYCJAMI.

SGA SYSTEM: THE STEP LADDER WITH ENDLESS POSSIBLE COMPOSITIONS.

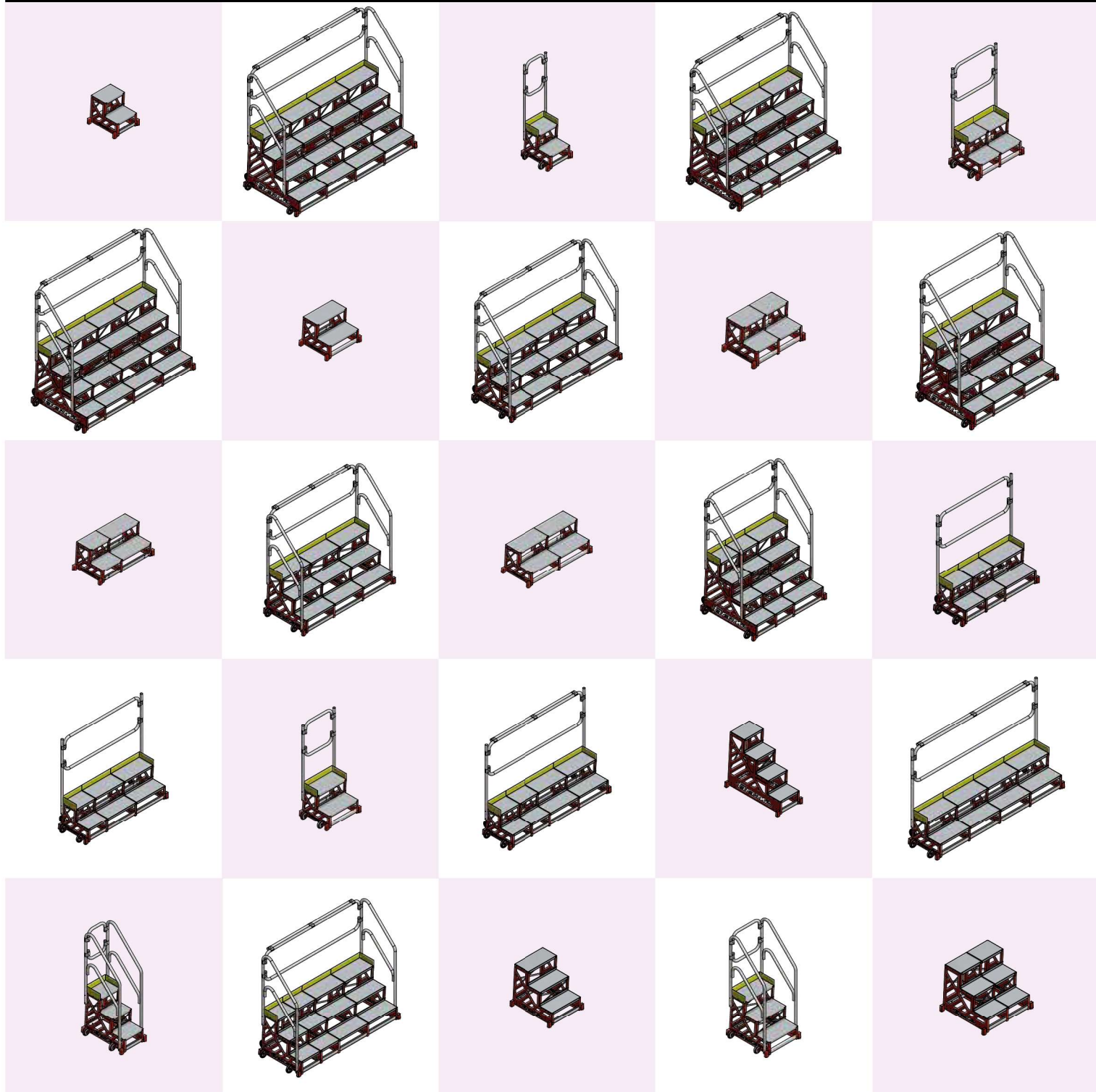

SCALA SYSTEM  
 KONFIGURATOR  
 KONFIGURUJ SWÓJ  
 SCALA SYSTEM.  
 CONFIGURE YOUR  
 SCALA SYSTEM,  
 GO TO THE  
 www.faraone.pl.

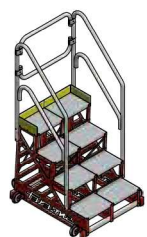
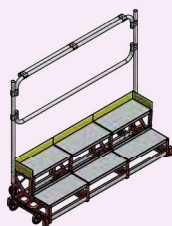
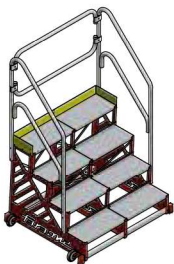
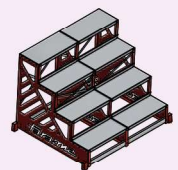
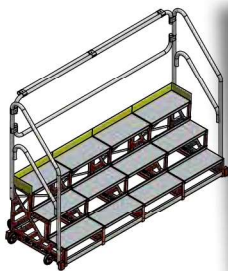
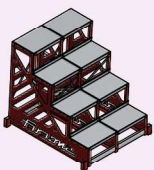
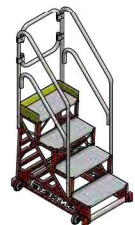
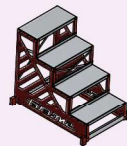
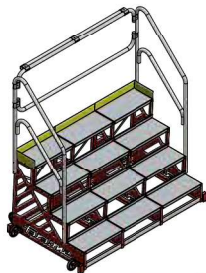
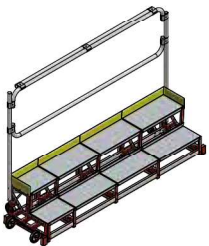
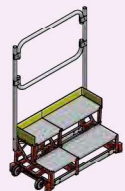
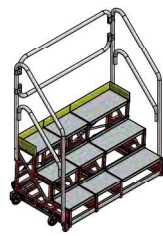
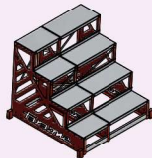
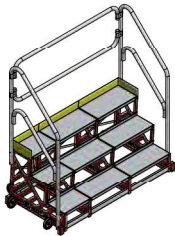
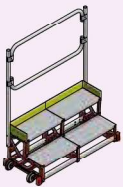
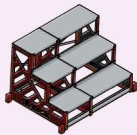
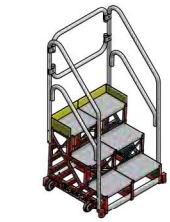

KONSTRUKCJA SPECJALNA. SPECIAL CONSTRUCTIONS

DOWIEDZ SIĘ W JAKI SPOSÓB KONFIGURACJĘ SYSTEM  
 SGA. FIND OUT HOW TO CONFIGURE YOUR SGA SYSTEM.



# SGA SYSTEM

System profesjonalnych schodów składanych z aluminiowymi stopniami antypoślizgowymi.  
The system of professional folding stairs with aluminum non-slip steps.



**tested**  
POLITECNICO DI MILANO

certificate



SCALA SYSTEM  
KONFIGURATOR

KONFIGURUJ SWÓJ  
SCALA SYSTEM.  
CONFIGURE YOUR  
SCALA SYSTEM,  
GO TO THE  
[www.faraone.pl](http://www.faraone.pl)



**Burta.**  
Toe board.



**Praktyczny uchwyt do przenoszenia produktu.**  
Practical handle to carry the product.



**Szerokie, o dużej wytrzymałości stopnie.**  
Wide high-resistance steps.



**Koło 80 mm ułatwiające poruszanie się.**  
80 mm wheel to promote movement.

"Zgodny z normami EN 131.7 i EN 14122. Niektóre konfiguracje systemu Scala, nawet jeśli przekraczają testy stabilności wymagane przez normy europejskie EN 131.7 i EN 14122 mogą nie spełniać tych norm pod względem wymiarów lub aspektów technicznych."  
"Compliant with EN 131.7 and EN 14122 Standards. Some Scala System configurations, even if exceeding the stability tests required by European standards EN 131.7 and EN 14122 may not comply with these standards in terms of dimensional or technical aspects."

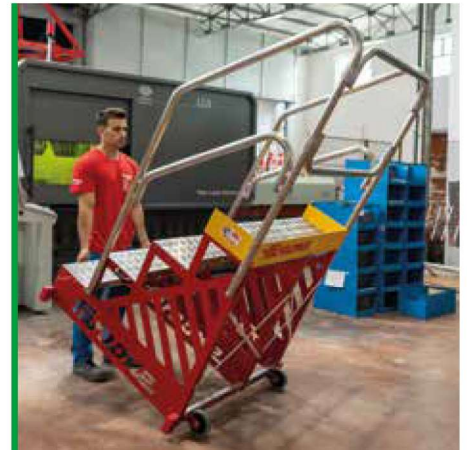

dane techniczne / technical specifications

**KONFIGURUJ SGA WG SWOICH POTRZEB / COMPOSE YOUR SGA SYSTEM**

**1 WYBIERZ PODSTAWOWY MODUŁ**  
CHOOSE THE BASIC MODULE

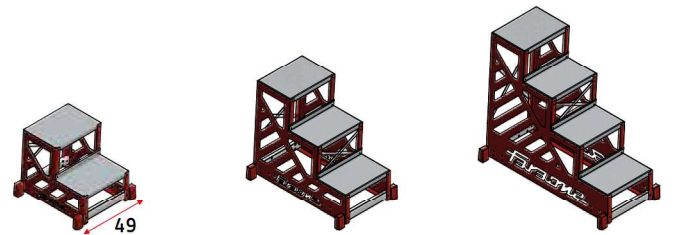

↑ **MODUŁ OD szer. 40 cm / MODULE FROM L. 40 cm**

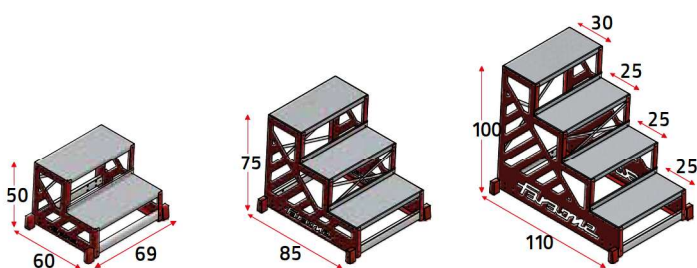

↑ **MODUŁ OD szer. 60 cm / MODULE FROM L. 60 cm**

**2 DODAJ KOMPONENTY**  
ADD COMPONENTS

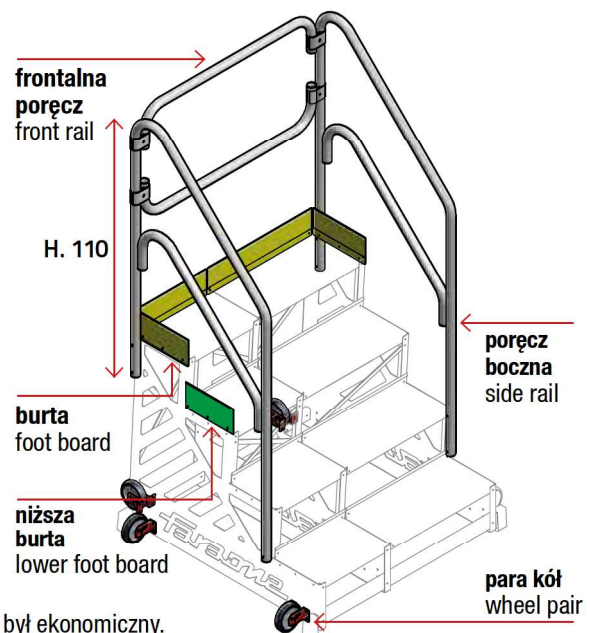

SCALA SYSTEM  
KONFIGURATOR  
KONFIGURUJ SWÓJ  
SCALA SYSTEM.  
CONFIGURE YOUR  
SCALA SYSTEM,  
GO TO THE  
[www.faraone.pl](http://www.faraone.pl)

System SGA jest dostarczany w stanie rozmontowanym, aby koszt transportu był ekonomiczny.  
The SGA System is delivered disassembled, to grant cheap freight costs.